

Features

- Compact and thin.
- Visible light cut-off type.
- High sensitivity.
- RoHS compliant.

Applications

- Cassette tape recorders, VCRs.
- Floppy disk drives.
- Various microcomputerized control equipment.

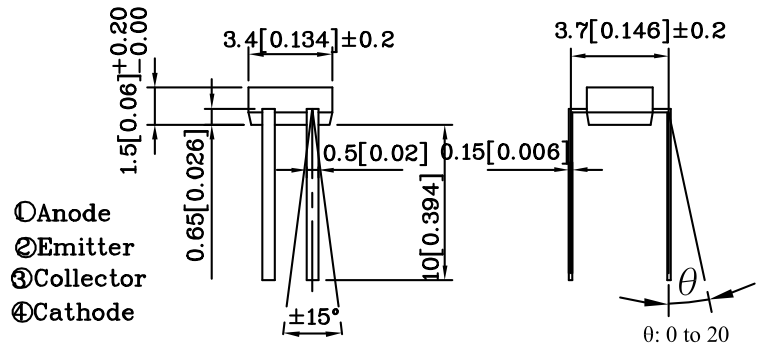
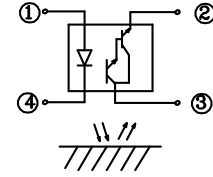
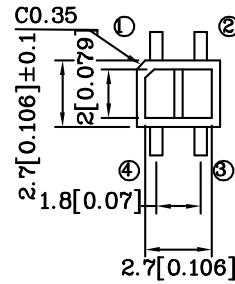

- ① Anode
- ② Emitter
- ③ Collector
- ④ Cathode

UNIT : MM[INCH]

TOLERANCE : ± 0.25[0.01"] UNLESS OTHERWISE NOTED.

Absolute Maximum Ratings (T_A=25°C)

Parameter		Symbol	Rating	Unit
Input	Forward current	I _F	50	mA
	Reverse voltage	V _R	6	V
	Power dissipation	P _d	75	mW
	Peak Forward Current (Pulse Width ≤ 100μS, Duty Cycle=1%)	I _{FP}	1	A
Output	Collector-emitter voltage	V _{CEO}	35	V
	Emitter-collector voltage	V _{ECO}	6	V
	Collector current	I _C	50	mA
	Collector power dissipation	P _C	75	mW
Operating temperature		T _{opr}	-25~+85	°C
Storage temperature		T _{stg}	-40~+100	°C
Soldering temperature (1/16 inch from body for 5 seconds)		T _{sol}	260	°C

Electrical / Optical Characteristics at $T_A=25^\circ\text{C}$

Parameter		Symbol	Conditions	Min.	Typ.	Max.	Unit
Input	Forward voltage	V_F	$I_F=20\text{mA}$	1.0	1.2	1.5	V
	Reverse current	I_R	$V_R=6\text{V}$	-	-	10	μA
	Peak Wavelength	λ_p	$I_F=20\text{mA}$	-	940	-	nm
Output	Collector dark current	I_{CEO}	$V_{CE}=10\text{V}, I_F=0\text{mA}$	-	-	10^{-6}	A
Transfer Characteristics	*1 Collector current	I_C	$V_{CE}=2\text{V}$ $I_F=4\text{mA}$	-	3	-	mA
	*2 Leak current	I_{LEAK}	$V_{CE}=5\text{V}$ $I_F=4\text{mA}$	-	-	5	μA
	Response time	Rise time	t_r	$V_{CE}=2\text{V}$ $I_C=10\text{mA}$ $R_L=100\ \Omega, d=1\text{mm}$	-	80	400
Fall time		t_f	-		70	400	μSec

*1 The condition and arrangement of the reflective object are shown below.

*2 Without reflective object.

Test Condition and Arrangement for Collector Current

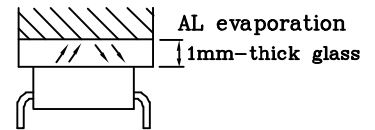

Fig.1 Forward Current vs. Forward Voltage

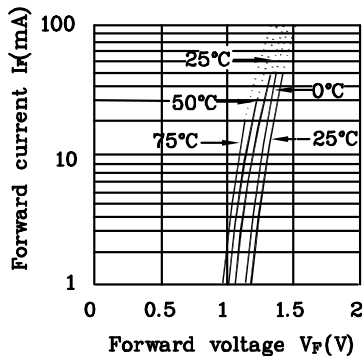

Fig.2 Collector Current vs. Forward Current

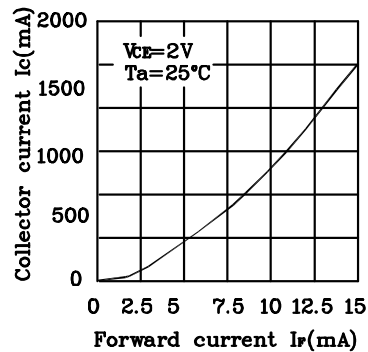

Fig.3 Collector Current vs. Collector-emitter Voltage

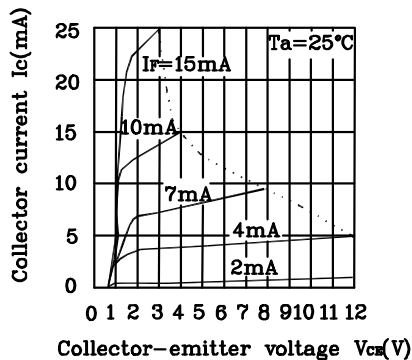

Fig.4 Relative Collector Current vs. Ambient Temperature

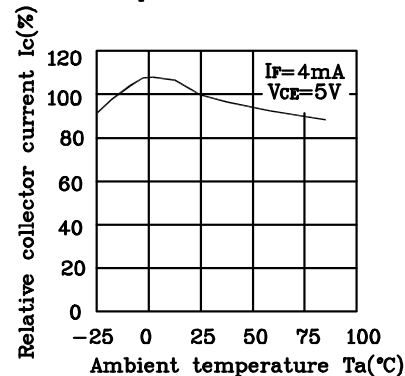
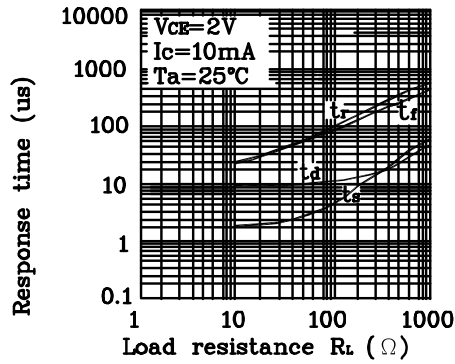

Fig.5 Response Time vs. Load Resistance



Test Circuit for Response Time

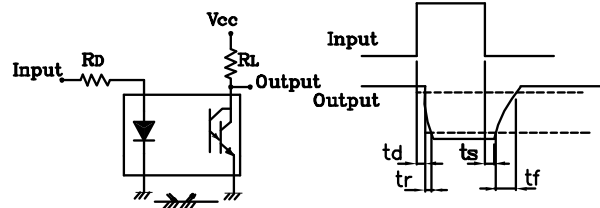

Fig.6 Collector Dark Current vs. Ambient Temperature

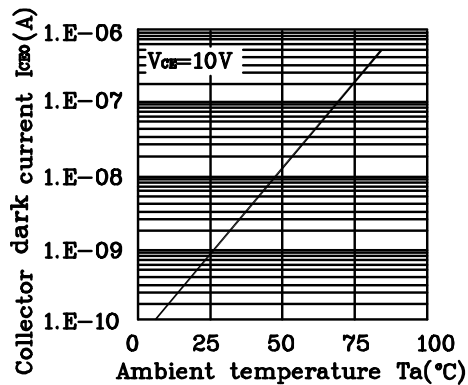

Fig.7 Relative Collector Current vs. Distance between Sensor and AL Evaporation Glass

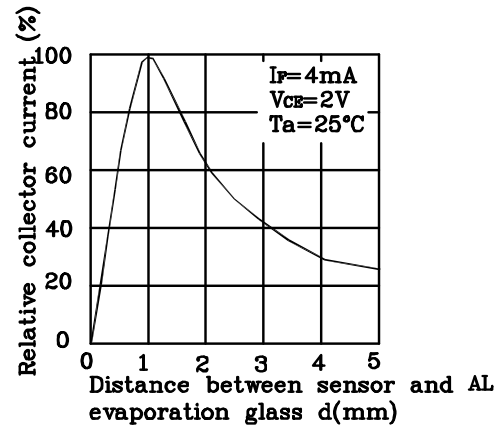

Fig.8 Relative Collector Current vs. Card Moving Distance(1)

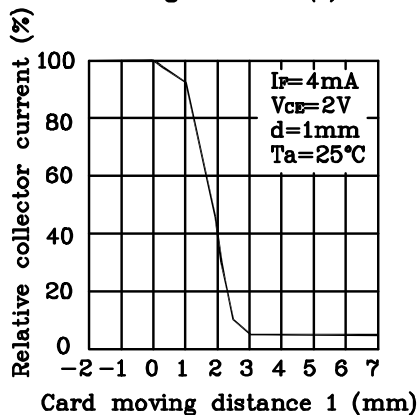
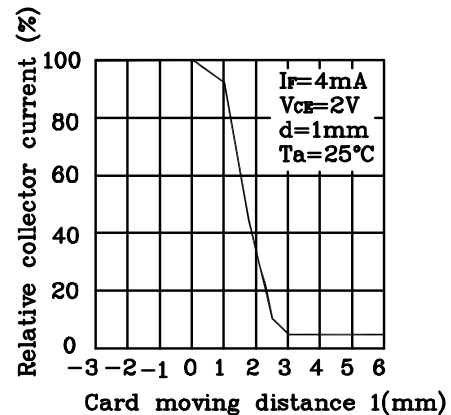
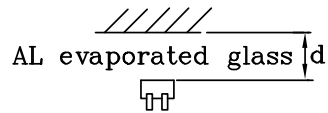

Fig.9 Relative Collector Current vs. Card Moving Distance(2)



Test Condition for Distance & Detecting Position Characteristics

Correpond to Fig. 7



Correpond to Fig. 8
Test condition

$I_F=4mA$
 $V_{CE}=2V$
 $d=1mm$

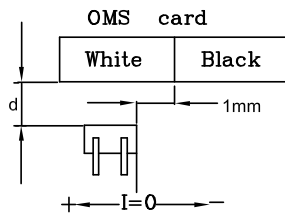

Correpond to Fig. 9
Test condition

$I_F=4mA$
 $V_{CE}=2V$
 $d=1mm$

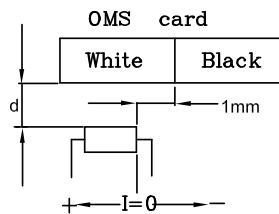

Wave Soldering Profile For Lead-free Through-hole LED.

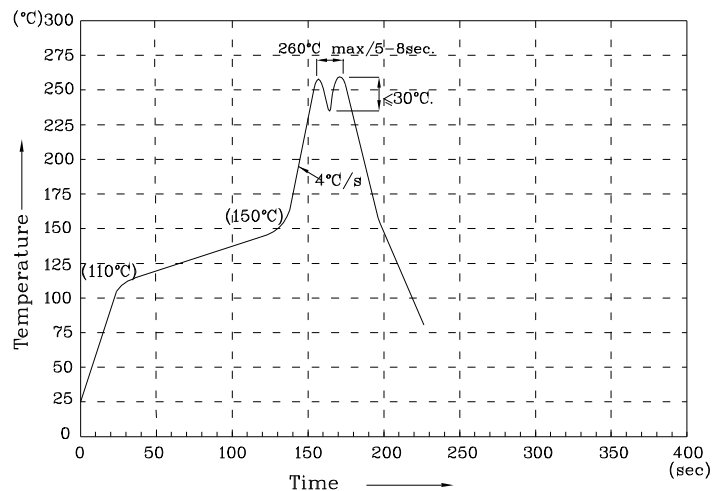

NOTES:

- 1.Recommend the wave temperature 245°C~260°C.The maximum soldering temperature should be less than 260°C.
- 2.Do not apply stress on epoxy resins when temperature is over 85 degree°C.
- 3.The soldering profile apply to the lead free soldering (Sn/Cu/Ag alloy).
- 4.No more than once.

PI-A17

